

AURA™ PRO INTERIOR

6PC INSTALLATION GUIDE

COMPONENTS



LIGHT STRIPS

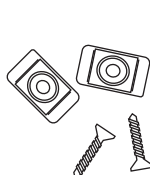

MOUNTING KIT

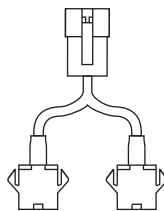

Y-SPLITTERS

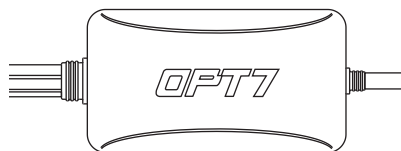

AURA BLUETOOTH CONTROL BOX



ZIPTIES



EXTENSION WIRES

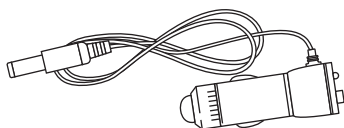

CIGARETTE LIGHTER POWER SUPPLY

INSTALLATION

STEP 1

Inspect kit to ensure all contents was included.

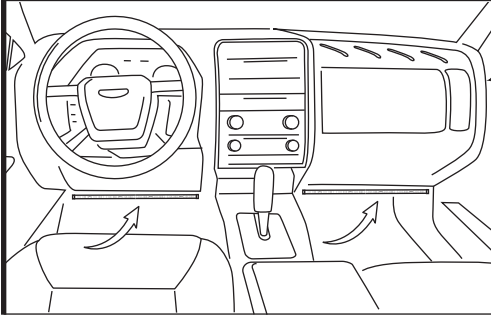

STEP 2

Decide where to locate the light strips and ensure wiring has enough length for control box to be installed in desired location.

IMPORTANT:

The control box must be installed inside the vehicle as it is not waterproof. **Avoid installation areas of the engine bay + heated surfaces.**

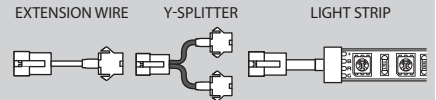

EXAMPLES

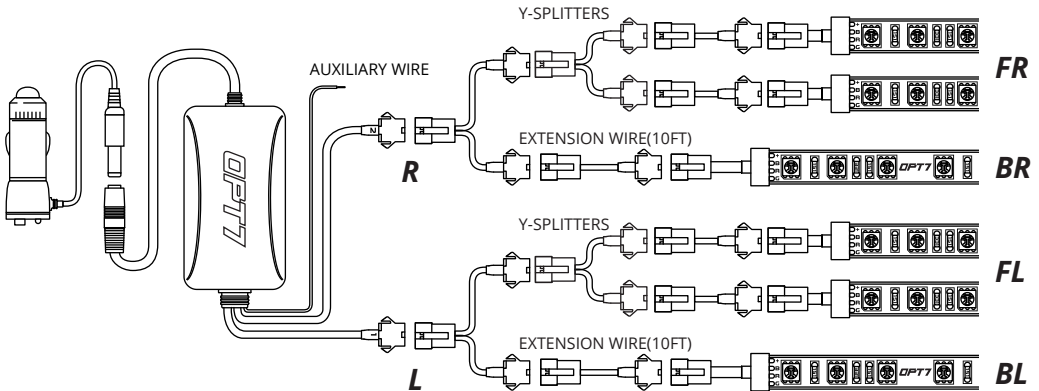

WARNING

1. Connecting to more than 10 AMP will override the kit and cause early failure, ensure it is 10AMPs or less!!
2. Please ensure that the LED bars or strips/control box/wiring all are mounted in areas where will not exceed 85°C or 185°F.

INSTALLATION

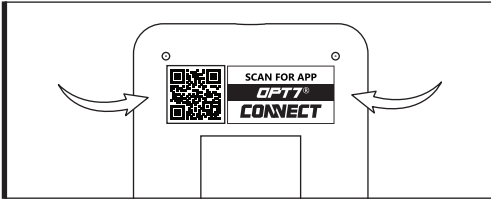

STEP 3

Scan the QR code on the back of the control box to download the app.

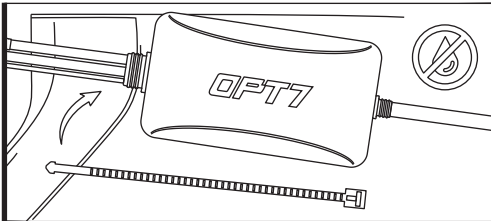

STEP 4

Secure Control box in desired location with Velcro or zipties.

* The control box is **NOT** waterproof. Tuck it away from the elements.

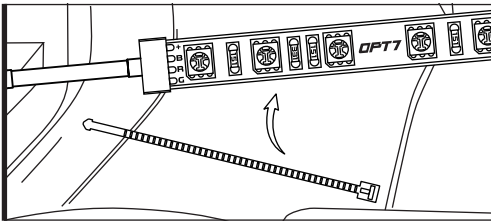

STEP 5

Secure the light pods using the zip ties to tie all the wiring away from the moving components.

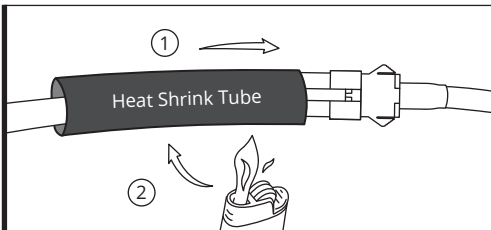

* IMPORTANT:

The LED connectors are not waterproof. You will need to use **HEAT SHRINK TUBE** (not included) or **ELECTRICAL TAPE** around the LED connectors to ensure the longevity of the lighting kit.

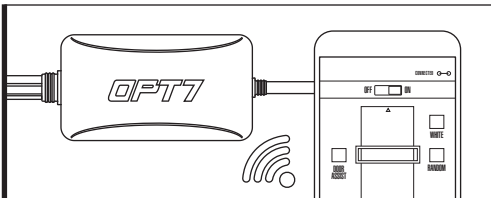

STEP 6

Open the "OPT7 Connect" App, pair your smart phone to the control box, and pick your desired color!



WARNING: Please ensure that the led bars or strips/control box/wiring all are mounted in areas where will not exceed 85C or 185F.

| AUX WIRING FOR A DOOR/DOME LIGHT



Please scan to see a detail instruction on Door Assist Sync or go to <https://wintis.ladesk.com/549690-AURA-Door-AssistAUX-Installation-Guide>

| OPT7 CONNECT APP

- Colors
- Modes
- Door Assist
- Support
- Ability to control up to 4 devices at once

QR CODE TO DOWNLOAD



Download the free "OPT7 CONNECT" App

- App iOS (12+) available on App Store
- Android (6 +) available on Google Play

| DISCLAIMER

OPT7 Lighting is not liable for damages or personal injuries while installing this product. The Installation Guide is intended as assistance to reduce setup time. OPT7 Lighting assumes no responsibility for improper installation. If you are unfamiliar with your vehicle or inexperienced with aftermarket upgrades, please seek professional assistance.

OPT7 recommends installation for safety and guidance.

Modified installations or installation recommendations not specified by OPT7 Lighting will void product warranty.