

AURA™

LED ROCK LIGHT INSTRUCTION MANUAL

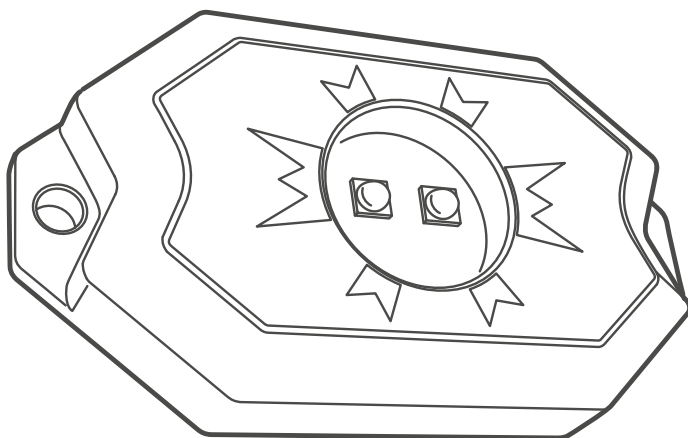

Rock Light
Durable DIY Design



Bluetooth
Control Features



Downloadable
QR Code
for Smartphone



Simple to Follow
Installation Guide

SPECIFICATIONS

Input Voltage	DC12V	Raw Lumens	340 LM(All 8 Pods combined)
input Power	13 Watts	Waterproof	IP68(Only Pod)
16LEDs	2 Four-Core Cree per pod	Operating Temperature	-5°F~120°F

WHAT'S INCLUDED

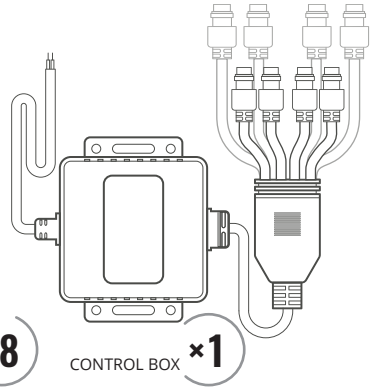
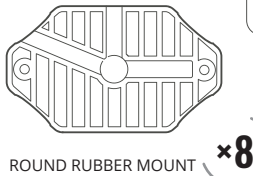
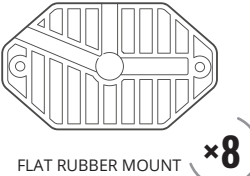
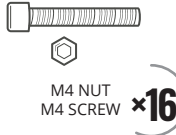
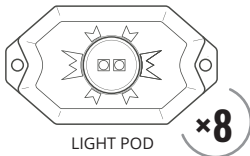

TWO WAYS TO MOUNT

FLAT /ROUND INSTALL WITH RUBBER MOUNT

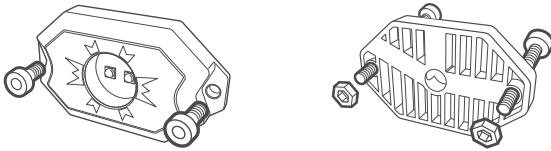

ROCK LIGHT POD FITMENT STEPS

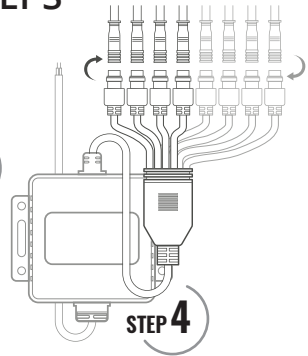
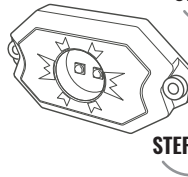
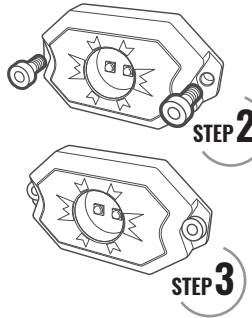
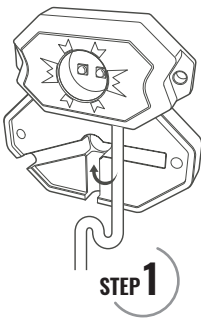

1. Make sure the pods are flush with the rubber mounts.
2. Begin inserting the screws into the screw holes.
3. Now you're ready to mount the pods onto your vehicle.
4. Once the pods are mounted, connect each pod power line to the fuse box power line ends and tighten the caps together with your fingers.

Remember, the rock light pods become extremely hot when in use, so you will not want to install the pods or control box underneath or on any sensitive material or power lines under your vehicle for safety.

WHERE TO INSTALL

INSTALLATION STEPS

1. Choose the mounting locations for each of the LED pods and the control box. Please refer to your vehicle's owner's manual for safe areas to install additional lighting and wiring.
2. Determine where the wires will run through. If needed, drill a hole(s) for the wire connector to pass through.
3. Mark and begin drilling each mounting hole with a 5/32" drill bit.
4. Install the LED Pods by themselves for a flat install or with the Rubber Mounting Pads for rounded surfaces.
5. Insert the two 25mm Screws through the LED Pod screw holes and Rubber Mounting Pad.
6. Secure the Screw and Pods with the Washers and Nuts to install flush with the drilled holes.
7. Secure the Pods by tightening the Screws for a snug fit away from any wiring or moving parts. Caution: The Pods become very hot during use, which can cause severe damage to any electrical, rubber, or moving parts that are exposed and too close to your Pods. Keep Pods away from any parts that can be damaged by extreme heat exposure.
8. Connect all of the Pod Cables to the Splitter Cable and secure by screwing locking collars from the Splitter Cable. Secure the Caps by tightening the end connections with your fingers.
9. Connect both sets of Splitter Cable input wires to the vehicle electrical system using additional power wire and fuse with fuse holder. Red is positive (+). Black is negative (-).
10. Once the Pods and Control Box electrical wiring are all safely connected to your vehicle's electrical system, you can now begin using the Rock Light Pods with the Bluetooth App on your Smartphone. Feel free to share a review of your installation with info about your exact off-road vehicle so other customers understand too! Rock on!

TOOLS REQUIRED

- 2.5mm Allen wrench
- 7mm wrench or socket
- 5/32 inch drill bit

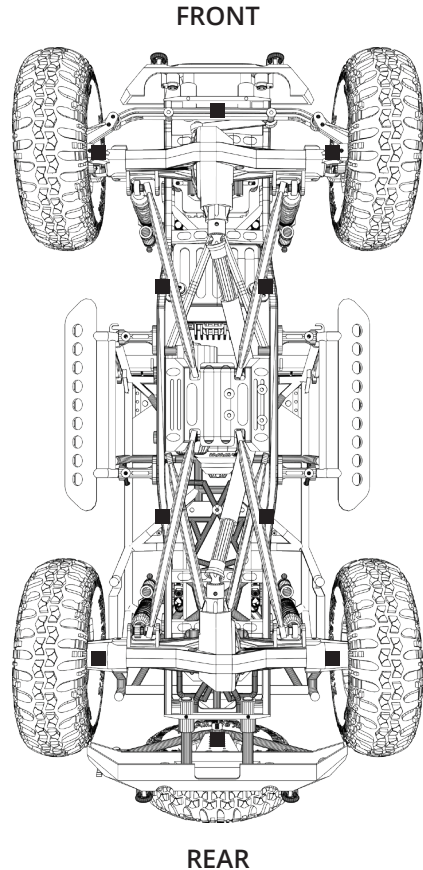

■ Rock Light Pods Recommended Locations

HOW TO USE THE APP

PRO RGB LIGHTING APP

Once you've downloaded the PRO RGB App, you will then turn on your Smartphone's Bluetooth connection and connect to the app. (See Figure 1)
You can use the App for up to 30 feet away from your vehicle.



PRO RGB
GUANGZHOU ZSOUL LED
LAMPS LIMITED

OPEN



Figure 1

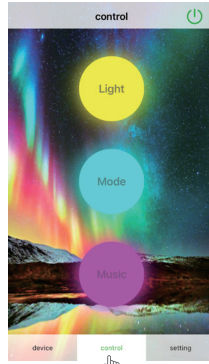

Figure 2

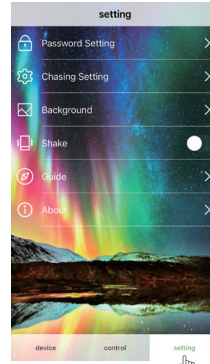

Figure 3

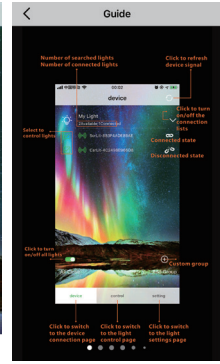
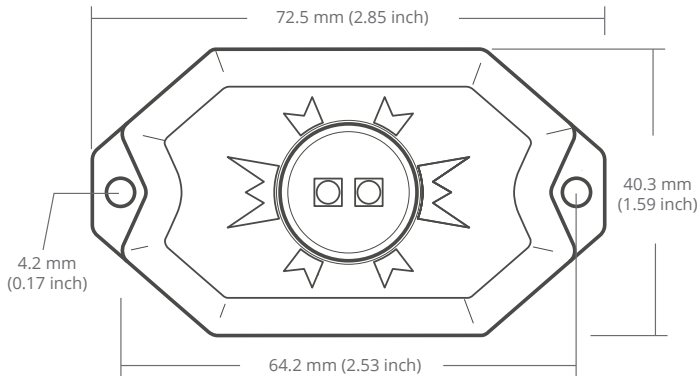

Figure 4

- 1 We provide you with 3 control methods for you to choose. You can quickly click the "Control" button at the bottom of the screen to easily control the style you want. (See Figure 2)
- 2 You can also click the "Setting" button to view the detailed information described in "GUIDE". (See Figure 3 & 4)

LED ROCK LIGHT POD DIMENSIONS



ROCK LIGHT FREE DOWNLOADABLE APP

Download the free PRO RGB app by taking a photo of the QR Code below, or go to either of these links:



COMPATIBLE WITH:

IOS 9.0 or later
<https://apps.apple.com/us/app/pro-rgb/id1485141574>

Android 4.4 or later
<https://play.google.com/store/apps/details?id=cs.com.testbluetooth>

