

AURA™ PRO

BLUETOOTH DRL HALO RGB DODGE CHALLENGER 08-23

INSTALLATION GUIDE

COMPONENTS



SINGLE COLOR LIGHT STRIPS

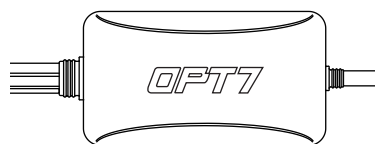

AURA BLUETOOTH CONTROL BOX



EXTENSION WIRES

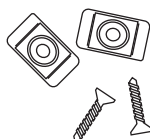

MOUNTING KIT

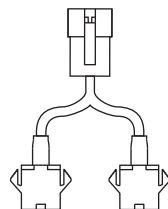

Y-SPLITTERS

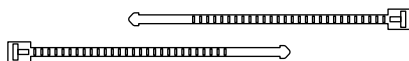

ZIPTIES

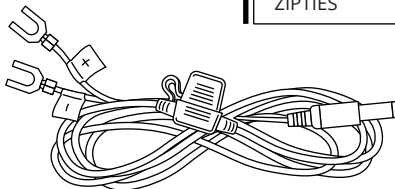

HARDWIRE POWER HARNESS

INSTALLATION

STEP 1



Open the hood.

STEP 2

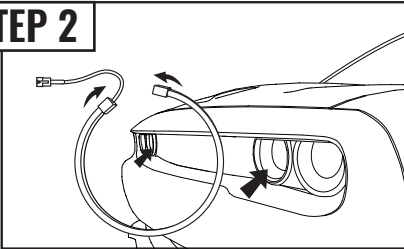

Wrap the LED strip into a circle shape and firmly press into place inside of the intake hole to secure.

AND/OR

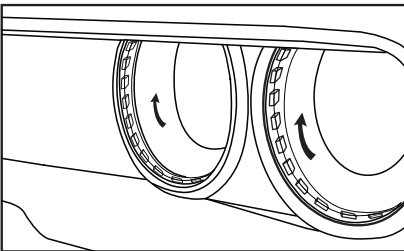

Attach the strip as pictured as an alternate method of install.

STEP 3

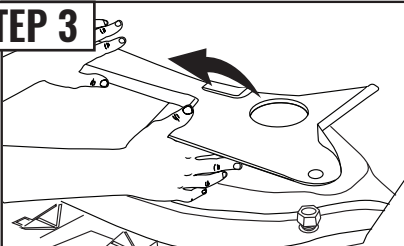

Remove the plastic covers on the right and left side of the engine bay.

STEP 4

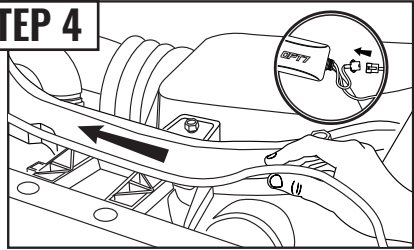

Run the wires along the front brace and connect to the control box.

STEP 5

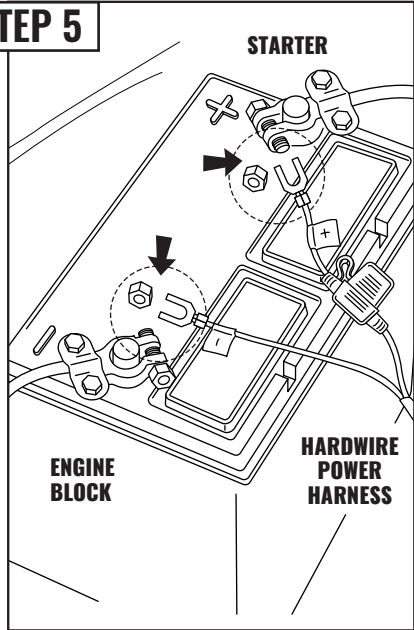

Connect the power wire harness to your vehicle battery.

STEP 6

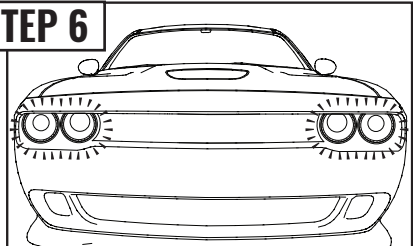

Test for function.

INSTALLATION

| EXAMPLES

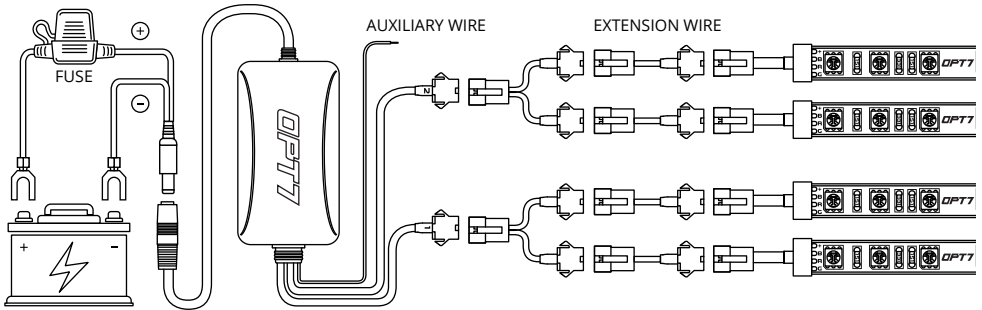

WARNING

1. Connecting to more than 10 AMP will override the kit and cause early failure, ensure it is 10AMPs or less!!
2. Please ensure that the LED bars or strips/control box/wiring all are mounted in areas where will not exceed 85°C or 185°F.

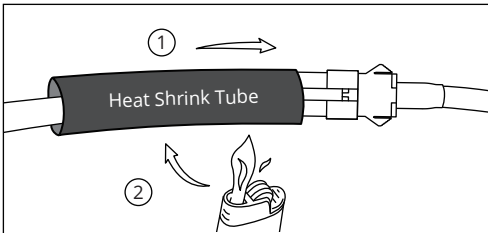

* IMPORTANT:

The LED connectors are not waterproof. You will need to use heat shrink tube (not included) or electrical tape around the LED connectors to ensure the longevity of the lighting kit.

| AUX WIRING FOR A DOOR/DOME LIGHT



Please scan to see a detail instruction on Door Assist Sync or go to <https://wintis.ladesk.com/549690-AURA-Door-AssistAUX-Installation-Guide>

| OPT7 CONNECT APP

- Colors
- Modes
- Door Assist
- Support
- Ability to control up to 4 devices at once

QR CODE TO DOWNLOAD



Download the free "OPT7 CONNECT" App

- App iOS (12+) available on App Store
- Android (6 +) available on Google Play

| DISCLAIMER

OPT7 Lighting is not liable for damages or personal injuries while installing this product. The Installation Guide is intended as assistance to reduce setup time. OPT7 Lighting assumes no responsibility for improper installation. If you are unfamiliar with your vehicle or inexperienced with aftermarket upgrades, please seek professional assistance.

OPT7 recommends installation for safety and guidance.

Modified installations or installation recommendations not specified by OPT7 Lighting will void product warranty.