

AURA™ PRO ENGINE BAY

INSTALLATION GUIDE

COMPONENTS



LIGHT STRIPS

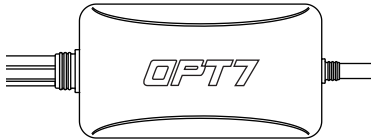

AURA BLUETOOTH CONTROL BOX



EXTENSION WIRES

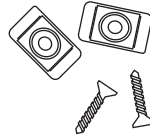

MOUNTING KIT

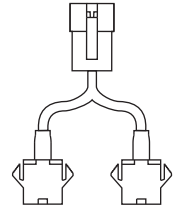

Y-SPLITTERS

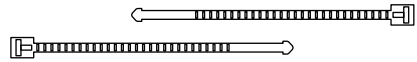

ZIPTIES

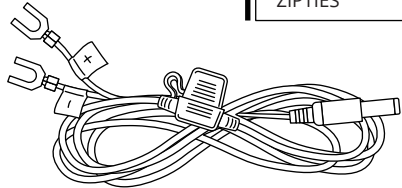

HARDWIRE POWER HARNESS

INSTALLATION

STEP 1

Inspect kit to ensure all contents was included.

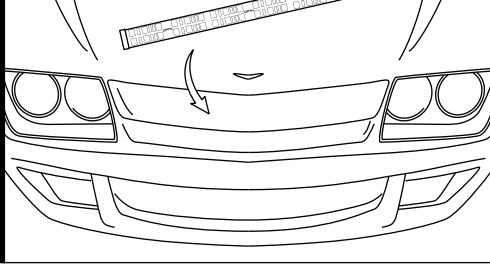

STEP 2

Decide where to locate the control box and light trips. Ensure wiring has enough length for light strips to be installed in desired location.

EXAMPLES

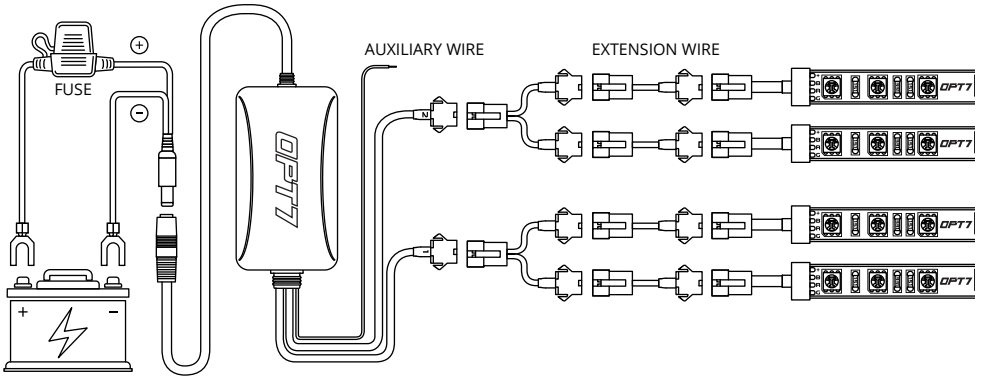

WARNING

1. Connecting to more than 10 AMP will override the kit and cause early failure, ensure it is 10AMPS or less!!
2. Please ensure that the LED bars or strips/control box/wiring all are mounted in areas where will not exceed 85°C or 185°F.

INSTALLATION

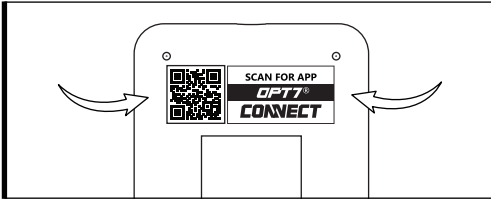

STEP 3

Scan the QR code on the back of the control box to download the app.

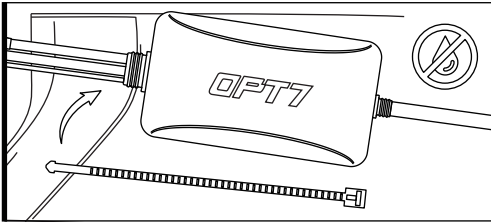

STEP 4

Secure Control box in desired location with Velcro or zipties.

* The control box is NOT waterproof. Tuck it away from the elements.

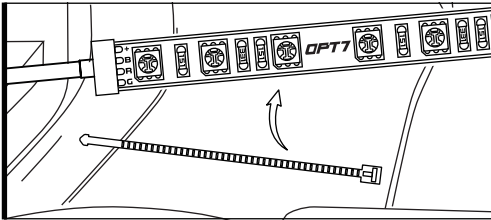

STEP 5

Secure the light strips using the zip ties to tie all the wiring away from the moving components.

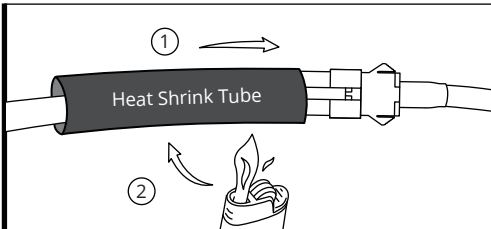

* IMPORTANT:

The LED connectors are not waterproof. You will need to use HEAT SHRINK TUBE (not included) or ELECTRICAL TAPE around the LED connectors to ensure the longevity of the lighting kit.

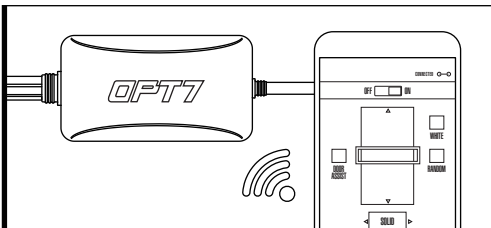

STEP 6

Open the "OPT7 Connect" App, pair your smart phone to the control box, and pick your desired color!

| AUX WIRING FOR A DOOR/DOME LIGHT



Please scan to see a detail instruction on Door Assist Sync or go to <https://wintis.ladesk.com/549690-AURA-Door-AssistAUX-Installation-Guide>

| OPT7 CONNECT APP

- Colors
- Modes
- Door Assist
- Support
- Ability to control up to 4 devices at once

QR CODE TO DOWNLOAD



Download the free "OPT7 CONNECT" App

- App iOS (12+) available on App Store
- Android (6 +) available on Google Play

| DISCLAIMER

OPT7 Lighting is not liable for damages or personal injuries while installing this product. The Installation Guide is intended as assistance to reduce setup time. OPT7 Lighting assumes no responsibility for improper installation. If you are unfamiliar with your vehicle or inexperienced with aftermarket upgrades, please seek professional assistance.

OPT7 recommends installation for safety and guidance.

Modified installations or installation recommendations not specified by OPT7 Lighting will void product warranty.